

Symbols for the sash adjustment when installed

These symbols facilitate the orientation while adjusting the window sashes after installation with the following steps. Use a 4 mm hex key as tool.

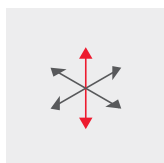

Height adjustment

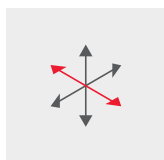

Lateral adjustment

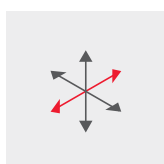

Gasket-compression adjustment



NOTE!

Adjusting Roto hardware components may only be carried out by authorised and qualified personnel.



NOTE!

The stated values in the adjustment instructions chapter are maximum values. These must be adhered to.

Adjustment

Adjustment instructions

Sash stay – Hinge side K

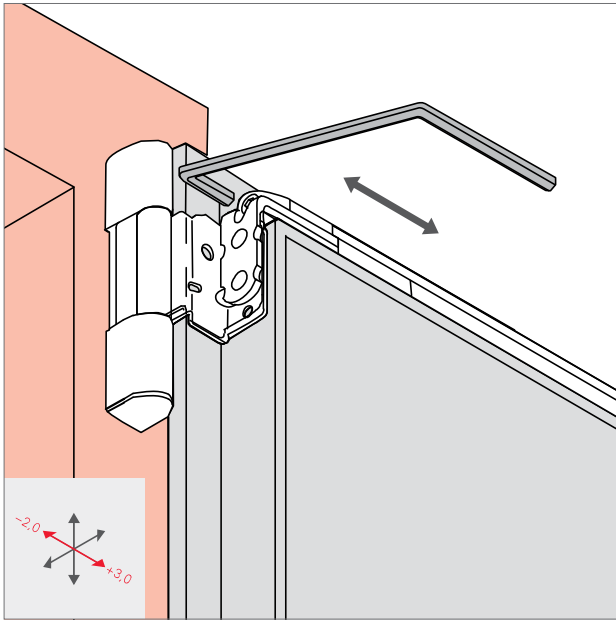

Lateral adjustment

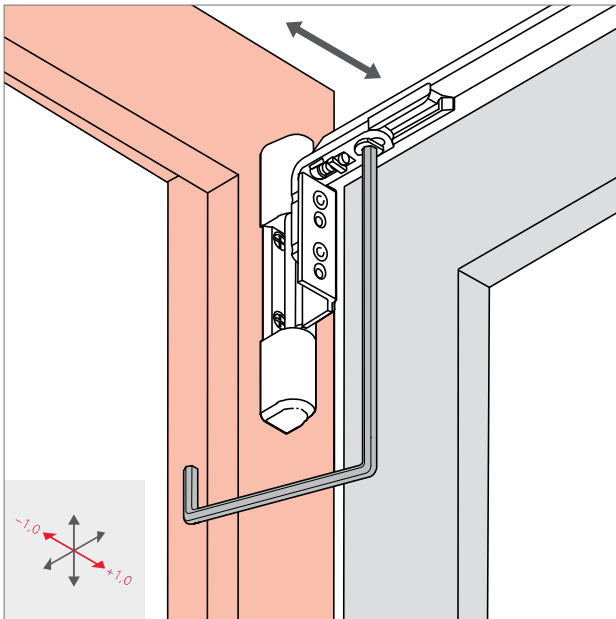

Gasket-compression adjustment

Adjustment

Adjustment instructions

Pivot rest / Corner hinge – Hinge side K

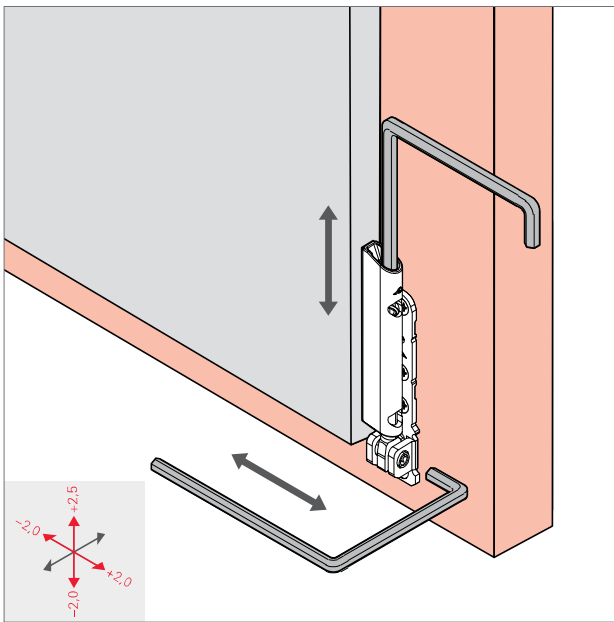

Height adjustment
Lateral adjustment









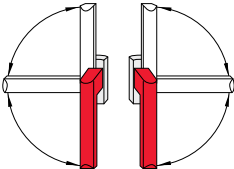
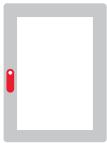

| Locking cam adjustment instructions | | | | | | |
|-------------------------------------|------------------|----------------------------------|----------------------|--------------------|--|-------|
| Cam type | Adjustment range | Gasket compression | Height | Side view | | Tools |
| E cam | | | | | | |
| | | | | | | |
| | 90° 90° | ±0.8 mm | | | | |
| P cam | | | | | | |
| | | | | | | |
| | 90° 90° | ±0.8 mm | | | | |
| V cam | | | | | | |
| Cam type | Adjustment range | Gasket-compression adjustment/mm | Height adjustment/mm | Side view/top view | | Tools |
| | | | | | | |
| | 90° 90° | ±0.8 mm | ±0.2 mm | | | |
| | 180° 180° | - | ±0.4 mm | | | |
| | 270° 270° | ±0.8 mm | ±0.6 mm | | | |
| | 360° 360° | - | ±0.8 mm | | | |

Operation

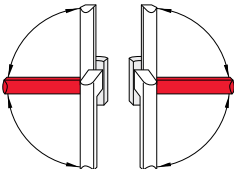
Operating information

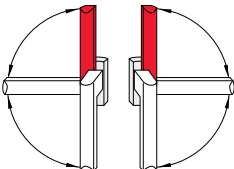
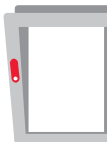
Handle positions of Tilt&Turn hardware

The following symbols show the different handle positions and the resulting sash positions of windows and balcony doors.

| Handle position | Sash position | Symbol | Meaning |
|---|---|---|-----------------------------------|
|  |  |  | Closed position of the sash. |
|  |  |  | Opened turn position of the sash. |
|  |  |  | Opened tilt position of the sash. |
| |  |  | Malpositioning of the sash. |



The following symbols and signs can be used on windows and balcony doors to protect the end-user.

Please order stickers separately (OPR_14_DE-EN).



Drehkipp-Beschlag
Tilt&Turn hardware

geschlossen
closed

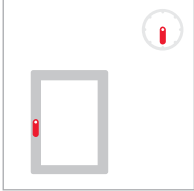

öffnen
open

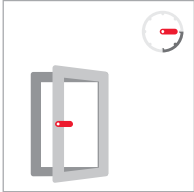

kippen
tilt

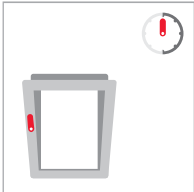

Fehlschaltungen vermeiden
Avoid mishandling mode!

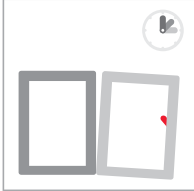

08/2012 OPR_14_DE-EN_v1