

Creation and Validation of Chronojump-Boscosystem: A Free Tool to Measure Vertical Jumps
Creación y validación de Chronojump-Boscosystem: un instrumento libre para la medición de saltos verticales

Xavier de Blas,
Universitat Ramon Llull
Josep M. Padullés
INEFC-Universitat de Barcelona
José Luis López del Amo
Universitat de Vic
Míriam Guerra-Balic
Universitat Ramon Llull

Abstract

Measuring the height of the vertical jump is an indicator of the strength and power of the lower body. The technological tools available to measure the vertical jump are black boxes and are not open to third-party verification or adaptation. We propose the creation of a measurement system called Chronojump-Boscosystem, consisting of open hardware and free software. Methods: A microcontroller was created and validated using a square wave generator and an oscilloscope. Two types of contact platforms were developed using different materials. These platforms were validated by the minimum pressure required for activation at different points by a strain gauge, together with the on/off time of our platforms in respect of the Ergojump-Boscosystem platform by a sample of 8 subjects performing submaximal jumps with one foot on each platform. Agile methodologies were used to develop and validate the software. Results: All the tools fall under the free software / open hardware guidelines and are, in that sense, free. The microcontroller margin of error is 0.1%. The validity of the fiberglass platform is 0.95 (ICC). The management software contains nearly 113.000 lines of code and is available in 7 languages.

Key words: biomechanics; jump; free software; open hardware; chronojump-boscosystem.

Resumen

La medición de la altura del salto vertical es un indicador de la fuerza y potencia del tren inferior. Los instrumentos electrónicos disponibles para medir este salto son cajas negras que no permiten la verificación ni la adaptación por parte de terceros. Proponemos la creación de un sistema de medición llamado Chronojump-Boscosystem, que consiste en un hardware abierto y un software libre. Métodos: Se ha creado un microcontrolador y se ha validado usando un generador de ondas cuadradas y un osciloscopio. Se han desarrollado dos tipos de plataformas usando materiales distintos. Las plataformas se han validado determinando su sensibilidad en distintos puntos por medio de una célula de carga, y por comparación con la plataforma de contactos del sistema Ergojump-Boscosystem en una muestra de 8 sujetos, realizando saltos sub-máximos con un pie en cada plataforma. Se ha usado una metodología ágil para el desarrollo y validación del software. Resultados: Todas las partes que componen el sistema se han licenciado como software libre o hardware abierto. El margen de error del microcontrolador es de 0,1%. La validez de la plataforma de fibra de vidrio es de 0,95 (ICC). El software de gestión tiene cerca de 113 mil líneas de código y está disponible en 7 idiomas.

Palabras clave: biomecánica; saltos; software libre; hardware abierto; chronojump-boscosystem.

Correspondencia/correspondence: Xavier de Blas
Universitat Ramon Llull. España
E-mail: xaviblas@gmail.com

Introduction

The assessment of force and/or power can be carried out by way of isometric tests, maximum lifting load tests, isokinetic tests, tests that determine mechanical power by using weights and a stop-watch, anaerobic power tests, throwing tests, horizontal jump tests and vertical jump tests, among others. Vertical jump tests have been traditionally used in the evaluation of physical education, including the Sargent Vertical Jump test (Sargent, 1921), Abalakov Jump Test (Abalakov, 1938), jumps over obstacles, the calculation of mechanical power by way of a vertical jump test, and the Bosco Test (Bosco, Luhtanen and Komi, 1983).

The Bosco tests are comprised of a set of tests in which flight time, and occasionally, contact time, is measured. This set of tests consists of several standardised tests: Squat Jump (SJ), Squat Jump with variable loads (LJ), Counter Movement Jump (CMJ), Drop Jump (DJ) and Reactive Jump (RJ). According to Padullés (2011), the results are a great help in training regimens, as they make it possible to: design the load-height curve of a jump, design the force-velocity curve, select the optimum workloads, select the optimum height of a DJ, determine the ideal number of repetitions, and create specific tests for each speciality. Different authors have developed indexes from the jumps of the Bosco Tests: Bosco Index (Bosco, 1986), Elasticity Index (Bosco et al., 1983), Reactivity Index (Bobbert, 1990), Arm Utilisation Index (Vittori, 1988, cited in Padullés, 2011), and Rapid Force Resistance Index (Portolés, 1994). In addition, Bosco developed a method that allowed the indirect estimation of slow and fast muscle fibres without having to resort to a muscle biopsy (Bosco, 1987).

The electronic instrument that was conceived for the measurement of the Bosco Test was called the Ergojump-Boscosystem. This system consists of a contact platform connected to a microcontroller. The contact platform (Figure 1) is made up of a number of pairs of equidistant, parallel metal bars. Each pair of bars work as a contact, meeting to touch when the individual is on them, then returning to their original position when there is no applied pressure. The equivalent electrical circuit shows the push-buttons connected in parallel, which in turn are equivalent to a single push-button which closes the circuit when the subject is on the platform.

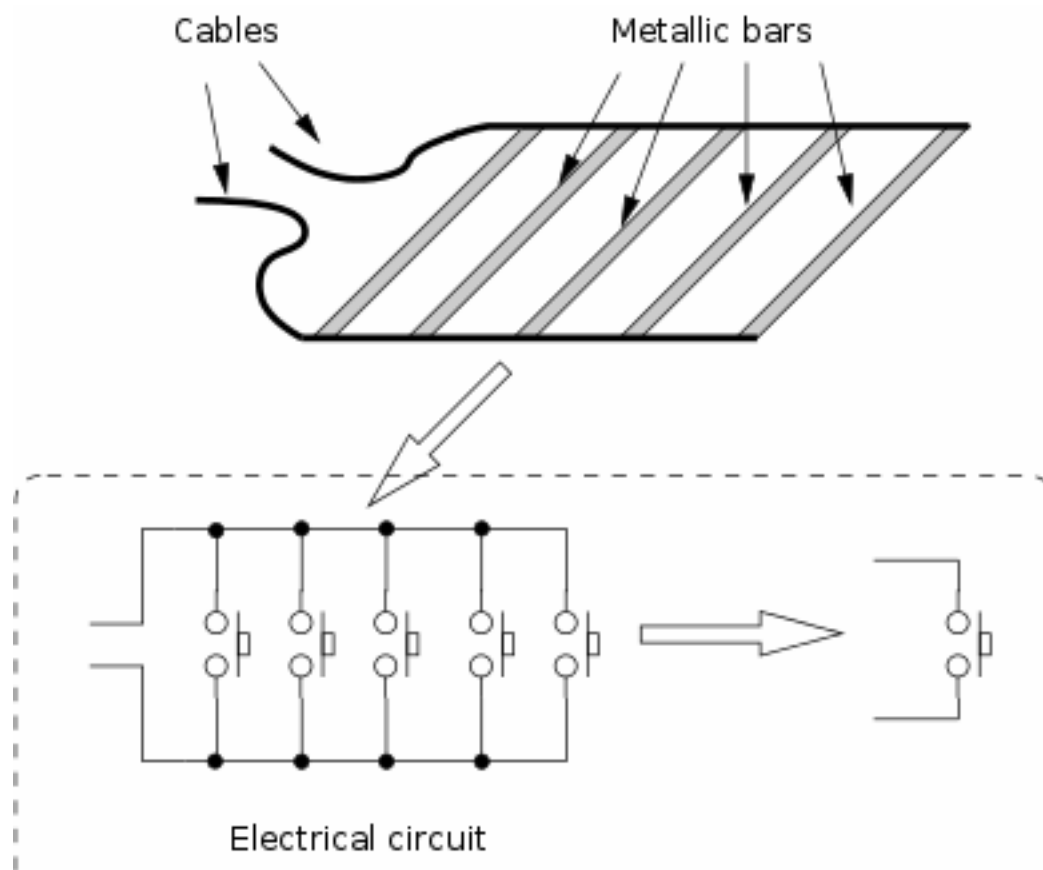

Figure 1: Diagram of the Ergojump-Boscosystem contact platform and the equivalent electrical circuits. (Adapted from De Blas and González-Gómez, 2005).

In the commercial versions of these platforms the distance between the pairs of bars has varied, with some being as great as 10 cm. This distance is too big and gives rise to reliability errors when the tip of the foot lands on a space between the bars. In the take-off, this error manifests itself as an early detection of the start of the jump, whilst in the landing it gives a late reading. For this reason, it is not recommended to use platforms with bars separated by more than 5 cm. There are also platforms available which use infra-red beams that have the following advantages: the possibility of doing tests on athletic tracks, including whilst using running spikes, less fear of slipping on landing, and an increase in durability due to the absence of deterioration caused by humidity (López, Padullés & Tous, 1999). On the other hand, the infra-red platforms are much more expensive.

Contact and infrared platforms estimate jump height assuming that the center of mass of the jumper is placed at the higher point just in the middle of the flight phase. This fact is only true when the center of mass in the take off moment is at the same height that in the touchdown. Kibele (1998) analyzed the difference between the average of jump height throughout the time of flight and the same measure with a numeric integration of force on a force platform. This author showed a difference between the height of the center of mass in the take off which induced an increase of the estimated jump height using the time of flight. Nevertheless, this difference was not statistically significant. On the other hand, Lara (2007) found that the center of mass of the subject in the touchdown was placed 4.28 ± 2.70 cm below to the take off position (see left-part of figure 2). This finding resulted in an overestimation of 2.1 cm of the height reached by the subject. In a pilot study previous to this manuscript it was suggested

to perform a quick drop jump just after the fall from the first jump. This second jump is not recorded and his goal is to promote an adequate position for the second jump. Importantly, the rebound movement facilitates an active preactivation which induces an extension of legs and a plantar flexion of feet. Thus, second jump contributes to a landing position in the first jump similar to the previous take off phase. This study reported, in a qualitative form, that this change in the protocol decreased the estimated error on the measurement of the jump height when it was estimated through the time of flight. This fact is due to that the positions in the touchdown and the take off are very similar and, consequently, the location of the center of mass does not have a great variation (see right-part of figure 2).

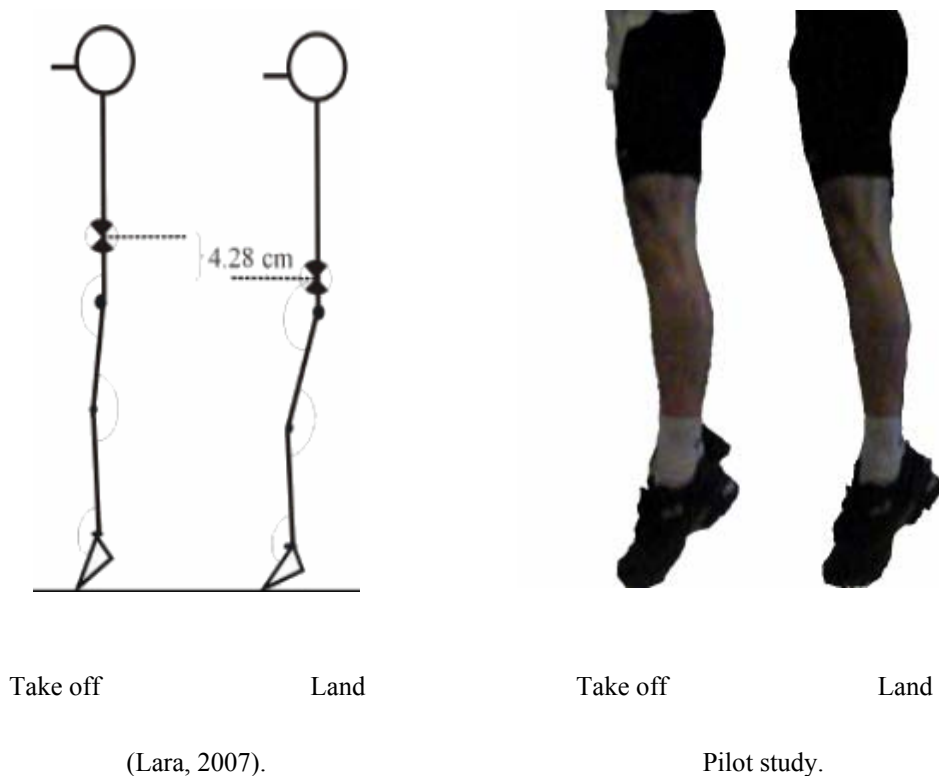

Figure 2: Difference in the take off and touchdown positions in the CMJ. The left image shows the average difference between different executed jumps. The right image corresponds to a pilot study where a quick rebound was executed after the landing.

The force platform –making a difference with the contact platforms and photocells- reports the value of force during the whole movement on the vertical axis or on the three axes. Force platforms designed specifically to assess the vertical jump, show results of flight time and/or contact at the end of the jump, while in the generic force platforms the information is taken from a graph such as the figure 3. Despite that the analysis of the force graph to obtain the time of flight is interesting for teaching (Linthorne, 2001) and that force platforms are identified as the Gold Standard to measure jump height (Hatze, 1998; García López et al., 2005), it is known that the use of the force platforms has several limitations for the use outside the laboratory. For instance, it is difficult to obtain a quick report of the results. In addition, force platforms have an elevated cost and reduced mobility as well as they require an accurate calibration.

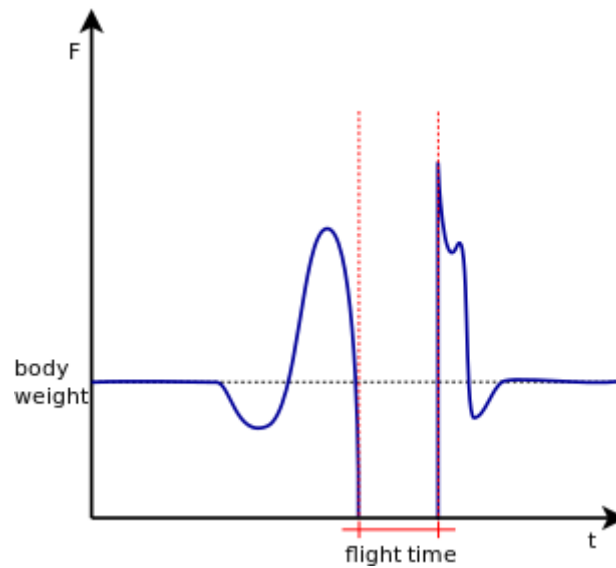

Figure 3: *Flight time recorded using a force platform.*

Accelerometers are another alternative to the contact platforms. Thompson & Bemben (1999) performed a validation of several accelerometers in order to estimate the power of the upper body. Regarding the lower body, several systems have been designed to measure the acceleration during a jump through the use, in occasions, of gyroscopes. Accelerometers calculate the distance reached (height of the jump) using a double integration. However, this fact induces an elevated error which needs to be corrected by the application of filtrated-algorithms. In addition, although accelerometers have shown a well-validity to assess jumps (Casartelli, Müller & Maffiuletti, 2010; Picerno, Camomilla & Capranica, 2011), the use of these devices has an important limitation. Accelerometers require a very stable position (without movements) before to the impulse phase of the jump in order to identify the start of the movement.

Thus, for all these reasons, the most common electronical method to assess the jump height in sport is the use of contact and infrared platforms.

The platform is supplemented by the microcontroller, which is used to feed and record the changes of state. Specifically, a microcontroller is a chip or an integrated circuit that has the three functional units of a computer: Central Processing Unit (CPU), memory, and associated peripherals. The microcontroller is connected to a printed circuit board that allows it to communicate with other integrated circuits connected to, and normally mounted on, the same board. The programme which runs the microcontroller, which is called *firmware*, as it is considered to be both hardware and software, has a part of the code already integrated into the device. Any change of state in the platform is detected by the microcontroller thanks to the change in the state of the electrical circuit (open <-> closed). Because of the multiple connections to the platform, this state change is not 'clean', and the firmware has to eliminate the spurious pulses or electronic rebounds that could arrive a few milliseconds after the state change.

The IT tools found for the measurement of jump height based on the measurement of distance, time or acceleration are black boxes. In other words, they can be used, but the user cannot have access to their content. Third parties are unable to completely verify the reliability of the tools, nor can they be adapted to individual needs.

Stallman (2002) called private software ‘software that restricts users freedom’ and defined free software as that which complies with four kinds of freedom:

- Freedom 0: to run for any purpose.
- Freedom 1: to study how it works, and change it to make it do what you wish. This demands access to the source code.
- Freedom 2: to redistribute copies so that you can help your neighbour.
- Freedom 3 to improve and release these improvements (and modified versions in general) to the public, so that the whole community benefits. Access to the source code is a precondition for this.

The benefits of free software have been identified by different sources. The IT consultancy company Gbdirect highlighted the following: reliability, stability, auditability, cost, flexibility, freedom, support and responsibility (Gbdirect, n.d.). Wheeler (2007) carried out a detailed analysis of the benefits of free software in terms of the quality of the software (reliability, performance, scalability and security), as well as in market terms (market share, cost of ownership, innovation and support) and finally, in terms of such aspects as freedom, protection against litigation, and flexibility. The U.S. Department of Defence signalled as benefits the increased reliability, security, flexibility, freedom of use and cost (U.S. Dept. of defence, 2009). At NASA’s Open Source Summit in 2011, Wheeler (2011) affirmed that: “In many cases, free software has the potential to increase functionality, quality and flexibility, while lowering cost and development time.” Di Bona (2011), speaking on behalf of Google, highlighted the independence from external software companies, the ability to repair and improve their services, and the closeness to Google’s ethics as the reasons for the company relying on free software.

Parker (2000) described the implications of free software for science. According to the author, the scientific method is a process of discovery and a process of justification, and scientific results must be replicable. For this to happen, the software tools used have to be accessible in the future. Private software does not make the use of old versions of software easy, whereas with free software all published versions are usually available on the official servers. In addition, free software emphasises peer review, as the source code for applications licensed in the manner is reviewed and corrected by the user community free of charge. In terms of hardware, authors prefer the use of “open” term instead of “free” because it cannot be massively replicated without cost. González, González & Gómez-Arribas (2003) posit that open hardware must be generated on the basis of a design that offers the four kinds of freedom of free software in the schematic [file that indicates the logical components and the signals connecting between them], PCB [file that specifies the physical location of the components, their dimensions, how they are packaged and what pathways are followed by the tracks to connect their pins] and the GERBER file, which contains the information required for the manufacturing (the latter may not be available). As all the source code on software and design files on hardware are available, free software and open hardware products use to be low cost (or zero cost on some software), because anyone can take the sources and produce their own products. This approach involves the transformation of the software industry into a services model (González-Barahona, 2003) where a software developer can publish freely his production earning money from services attached to it (Galli, 2004).

The purpose of this research is to “Create and validate a free software / open hardware tool that measures the contact and flight times of the vertical jump, using a contact platform”.

Methods

A) Methods for the construction of the tools

The microcontroller was designed with the free tool KiCad (KiCad Developers, n.d.). The firmware was programmed in assembler language using GNU tools made up of gputils and the gpsim simulator. A bootloader was programmed so that the firmware could be easily updated from any computer. An application was created in Python to enable the programming of the firmware in the Windows and Linux operating systems. The microcontroller was built in various stages to allow it to develop from a national, manual manufacturing context to an international industrial production environment. The microcontroller was called Chronopic.

The contact platforms were built using pairs of conductive materials separated in some areas by non-conductive material. When the weight of the subject overcomes the pressure of the non-conductive materials, a contact is made between the circuits due to the microcontroller feed, in the same way as the contact platform designed by Carmelo Bosco (Bosco et al., 1983) as described by Buscà, De Blas & Daza (2004). With the aim of satisfying the needs of different trainers, two types of platforms were designed: one rigid and the other one flexible. Different sizes of platforms were experimented with.

In terms of the rigid platforms, two models were created, one sized A2 and the other one A3. They were constructed using sheets of fiberglass, one above the other, separated by double-sided tape. The fiberglass plates were laminated with copper on each surface to ensure their conductivity. The double-sided tape was placed along the four sides of the platform in order to keep them close together but ensuring separation of the two until the resistance of the platform is overcome by the weight of the subject. The tape was placed intermittently so that the platform could 'breathe' and so avoid the production of a 'vacuum' as the individual takes off; this would cause the plates to stay in contact too long and falsely shorten the measurement of the jump. In the case of the A2 platform, a small piece of tape was placed in the centre in order to avoid it becoming deformed due to its large size. The connection cable with the microcontroller was soldered to the lower plate and the connection was protected so that there was no contact with the upper plate. To avoid injuries, improve adherence and improve the appearance of the apparatus, the plates were covered with vinyl, taking good care to allow the platform to breathe at the sides.

The flexible platform was made using 1 cm thick polyester foam. The foam was perforated with a 3 cm drill. As many perforations as possible were made, the limiting factor being to avoid the holes touching. The upper and lower faces of the foam were then covered with two further pieces of 0.4 cm thick foam, above and below, respectively. These new foam boards were laminated and had a thin aluminium layer on the face that would make contact with the polyester foam. The three layers were held together with masking tape. The whole was then finally covered in nylon and PVC.

Compared to the traditional 'bar' platforms, the new platforms had the benefit that the whole of the surface area could make a contact. Because of this, the platforms avoided giving false contacts or problems resulting from contact of the tip of the foot being between the bars on take-off or landing. Whilst the rigid fiberglass platform had the advantage over the bar platform that it is more conductive and has more resistance to bending, the flexible platform had the advantage of being more portable.

The computer software was designed according to the principles of agile methodologies, which prioritise the publication of new functionalities and versions over the rigidly scheduled version releases typical of traditional release methodologies (Fowler & Highsmith, 2001). The new versions (or *iterations*) were planned based on the requests received for new functions (known as ‘user stories’) made by future users. The following free tools were used in the development of the software: Autotools, C#, Gettext, Glade, Grep, Gstreamer, GTK#, Innosetup, Linux, Mono, R, Sqlite, Vim, and VirtualBox OSE.

B) *Methods for the validation of the tools*

The microcontroller was validated by the use of Hameg HM 8035 and Hameg HM 8030-4 square-wave generators, together with an Agilent 54621A oscilloscope.

As the shortest contact times of a jump do not tend to be lower than 150 ms and the longest are not above 700 ms, this range of values was used. To generate these values, square waves were used at specific frequencies, as explained in Table 1.

Table 1: Equivalent frequencies and times used in the validation of the microcontroller.

Frequency (Hz)	Total time (ms)	TC or TF (ms)	Comments
10.0000	100	50	Shortest time recorded.
3.3333	300	150	Estimated minimum TC of a jump.
0.7143	1400	700	Estimated maximum TF of a jump.
0.2500	4000	2000	Maximum time intended to be explored.

Experiments were conducted using frequencies outside the aforementioned value ranges to see how the microcontroller would respond to frequencies that could be used in different types of tests.

The following protocol was used: First, square waves with 50% duty cycle were created with the wave generators. The wave generators used were the Hameg HM 8035 -for the range between 9 Hz and 1.5 Hz, at intervals of 0.5 Hz-, and the Hameg 8030-4 -for the following frequencies: 1.5 Hz; 1 Hz; 0.5 Hz and 0.25 Hz-. The oscilloscope and the microcontroller were used to detect the waves. And finally the results were compared.

To avoid any interference between the hardware devices, the two generators were never used at the same time, nor were the generated waves ever captured by the oscilloscope and the microcontroller at the same time. Thus, the detailed protocol for capturing one wave frequency was the following: First, the wave was created by using the wave generator at the desired frequency (according to the controls of the generator). Then the oscilloscope was connected and the value shown by it was taken as the real value of the wave. Next, the oscilloscope was disconnected and the microcontroller was connected and the electrical impulses were recorded by the microcontroller. Finally, the values recorded by the microcontroller were compared to those of the oscilloscope.

In order to compare the results, the relative error for each time of contact (TC) and time of flight (TF) detected by the microcontroller with respect to the values detected by the

oscilloscope was calculated according to the following formula: Relative error (%) = $100 * |T_{exp} - T_{gold}| / T_{gold}$, where T_{exp} is the time found on the experimental contact platform, and T_{gold} is the flight time corresponding to the Gold Standard: the oscilloscope. Subsequently the arithmetic mean of the relative error in the contact times and the relative error in the flight times was obtained.

With respect to the validation of the contact platform, two methods were used. First, the minimum pressure necessary to make contact was checked at different points of the platform. It was understood that the lower the force needed to activate a platform, the more sensitive it is. Second, the activation/deactivation times of the proposed platforms were compared with each other and with the contact platform of the Ergojump-Boscosystem.

For the first validation, a strain gauge from the MuscleLab system (Norway), the Chronopic 3 microcontroller and a personal computer were used with the following procedure: Firstly, various marks were made at different points on the platforms, following the arrangement shown in Table 2. Then the MuscleLab strain gauge was calibrated by the use of a known weight. Next, the platform was connected to the Chronopic 3 microcontroller, which was in turn connected to a personal computer to receive the feed. 2 Kg and 1 Kg weights were placed on the platform to determine the minimum force (added weights + weight of the strain gauge) to close the circuit of the contact platform. This step was repeated on each of the points previously marked on the platform. Finally, a descriptive analysis was carried out, which consisted in obtaining the arithmetic mean and the standard deviation of the force necessary for the activation of the different points of each platform, and the results between platforms were compared.

Table 2: Coordinates of points assessed on each platform.

Rigid A2 (60x42 cm)				
(4, 5)	(17, 5)	(30, 5)	(43, 5)	(56, 5)
(4, 21)	(17, 21)	(30, 21)	(43, 21)	(56, 21)
(4, 37)	(17, 37)	(30, 37)	(43, 37)	(56, 37)
Rigid A3 and flexible A3 (42x30 cm)				
	(5, 5)	(21, 5)	(37, 5)	
	(5, 15)	(21, 15)	(37, 15)	
	(5, 25)	(21, 25)	(37, 25)	

For the second validation procedure -activation/deactivation times of the proposed platforms-, the following instruments were required:

- Two personal computers.
- Two Chronopic 3 microcontrollers.
- An Ergojump-Boscosystem contact platform, folded so that the distance between the bars was 5 cm.
- Three of the specially-built contact platforms: two rigid ones (Din-A2 size) and one flexible one (Din-A3 size).

The Ergojump-Boscosystem contact platform was used as the reference measure for being the original system and being widely used. The layout of the platforms is shown in Table 3. To ensure that athletes had both feet at the same level, a piece of thick rigid plastic was placed

beneath the Ergojump-Boscosystem platform. As the plastic was rigid, it was considered that it would not interfere with the outcome of the jumps.

Table 3: Layout of the contact platforms. The subjects had one foot on each platform.

	Foot 1	Foot 2
Location 1	Rigid A2 platform	Rigid A2 platform
Location 2	Rigid A2 platform	Bosco bar platform
Location 3	Bosco bar platform	Flexible platform

The sample consisted of eight adult male athletes from various athletics disciplines related to speed and jump. All the athletes were familiar with the Squat jump and its being measured by the use of specific instruments, since they often did this in their training sessions. Before taking part in the experiment, they were given an explanatory document and were asked for their informed consent, since their participation was voluntary. The following variables were obtained about each subject: age, height and weight. Table 4 contains the statistics about the sample.

Table 4: Sample for the validation of the platforms.

	Mean	Median	Standard Dev.	IQR
Age	24.2	23.2	3.4	2.0
Height	177.0	177.0	4.6	7.0
Weight	71.1	70.2	5.9	4.5

The following experiment was carried out: The athletes warmed up as they deemed suitable. They were divided into two groups. One of the groups carried out the jumps in locations 1 to 3, whilst the other carried them out in reverse order (3 to 1). Four jumps were done on each location; two with the body facing a wall and the other two facing the opposite way. The Squat jump used was done at submaximal intensity to ensure coordination in the legs, so that both legs took off and landed at the same time. A quick rebound was executed after the landing in order to decrease the variation in the location of the center of mass between the first take off and the first touchdown as explained in the introduction of this document. The instruction given before each jump was: “When you are ready, jump!” Care was taken not to alter the emphasis of each instruction. Measurements were recorded by two Chronopic 3 microcontrollers, each one connected to a platform and to a personal computer with the Chronojump software.

The results of the different jumps were compared in order to determine the reliability of the different platforms by the use of the statistical tool R (R Development Core Team, 2008). The statistical tests which were then performed were:

1. By the use of box charts, the concurrent validity of the platforms as compared to the Ergojump-Boscosystem platform was analysed. Furthermore, the conformity of the Din-A2 rigid platforms was ensured by comparing them using the same stimulus (one foot on each platform and a comparison of submaximal jumps: balanced).
2. A comparison of the results from the different locations was carried out in order to determine any lateral deviations to assess if there was a systematic error in any of the platforms that would lead to a tendency to give longer times than others.
3. The variability of the different athletes was studied in all the locations globally, as well as in each individual location.
4. Bland-Altman charts were then used to observe the differences in each location.
5. Finally, the intraclass correlation indexes were calculated for each location.

In the development of the software the main functionality was identified, i.e. to "capture data from the microcontroller". This functionality was tested and separated from the rest of the code. The software was allowed to mature, and the users were treated as developers following the philosophy of agile methodologies. Furthermore, tests were carried out using different testers before the publication of each version.

Results and discussion

To date three versions of the microcontroller have been developed and assigned the nomenclature Chronopic 1, Chronopic 2 and Chronopic 3. Chronopic 1 was an expansion card that was adapted to the Skypic board (González-Gómez & Prieto-Moreno, 2005). Production was started in Spain in 2005. The source files in KiCad as well as the GERBER build files and the drills can be found in the Chronopic 3 Technical Page (Gómez & González, 2008). The source code of the Firmware and the Bootloader were put in the Chronojump GIT subdirectory (Chronojump, n.d.).



Figure 4: *Chronopic 3. Made in Taiwan.*

The contact platforms are shown in Figure 5. Currently the rigid platforms are sold in the following sizes: Din A2, Din A3 and Din A4.



Figure 5: Main image; a photograph of the Rigid A2 platform, two inset images; photographs of the flexible platform.

The resulting software was called Chronojump. According to the web services provided by Ohloh (Black Duck Software, Inc 2012), as of 2nd May, 2012, the size of this programme was 112,810 lines of code (30% of which are mark-up lines). Also according to Ohloh, the COCOMO project cost calculation model (Boehm, 1984) is 28 people/years, with a total development cost of US\$1,521,372. The valuation by COCOMO is customary in the business software environment, but it is considered to be overestimated in free software projects, as the development methodologies are more flexible, as stated in Ohloh's own web page.

The software is compatible with both Windows and Linux. Its main purpose is to connect to the Chronopic 3 microcontroller and register jumps, as well as other time-based tests such as races, rhythm and reaction times. The tests, subjects and sessions are stored in a database. The software implements Bosco tests and other tests, and it also allows users to conduct their own tests. Visual and aural feedback is available on repetitive tests so that they could be directly used to control the training. It is also possible to record the jumps via webcam. Statistics and graphs frequently used in the field are included, which allow the generation of reports and the export of data, and lastly, it is possible to connect to a server to share data if so decided by the user, while ensuring the privacy of the data. The programme is available in 7 languages. Chronojump was awarded the prize of 'best free software' in 2007 in the Education category at the international competition "Les Trophées du Libre" by the CETRIL Foundation.

Regarding the validation of the microcontroller, the mean of absolute errors in all the frequencies was 0.13% in contact time and 0.14% in flight time. By comparison, taking into account only the frequencies in the 150-700 ms jump range, the mean of absolute errors was 0.1% and 0.18% for contact time and flight time, respectively.

With respect to reliability, the values obtained for any one frequency were always the same, except in the two unstable zones, which were found in the following ranges:

- Zone close to 50 ms: 53.248 ms – 50.251 ms.
- Zone close to 25 ms: 25 ms – 24.752 ms.

In these ranges reliability was lost, as different results were produced for the same incoming wave frequency. The results obtained were multiples of 50 in the area close to 50 ms and multiples of 25 in the other area.

One possible interpretation of this variability could be linked to spurious pulses. When an impulse is under 50 ms, it is disregarded as being spurious, whereas, on the contrary, it is accepted when it is equal to, or higher than, 50 ms. It is considered that a single stimulus sent to Chronopic is accepted or rejected without any problems; however, when the wave sent by the generator was a continuum of impulses, they appeared to interfere with each other when their frequency was close to the area in which their acceptance or rejection is determined, or a submultiple of such an area (zone close to 25 ms). In this case, it would be necessary to review the interruptions to the firmware to correct this error.

If the previous argument is accepted, this error is not significant for the location of the jumps, as the error only appeared when a continuous wave was sent (from the wave generator).

If the previous argument were not accepted, based on the premise that the error could arise in a jump session with people, it must be taken into account that it is highly unlikely that this error would occur, for the following reasons: First, it happens at a much lower range than the jump times (three times lower than the minimum contact times). Second, the amplitude of the range is very small: 3 ms. Last, the firmware has not been modified since 2005 and no users have complained about erroneous values from the microcontroller.

On the other hand, since a bad contact in platform might have a time included in one of the two referred areas, it is recommended, as a precaution, not to use platforms with bars too far apart from each other (that is, no more than 5 cm. apart), as this could lead to erroneous short times if the foot is incorrectly placed. Other factors that could lead to erroneous short times are: barefoot jumps on platforms made of bars; and jumps performed with bad technique, where a 'pre-jump' occurs (a small involuntary jump that participants make during the flexion phase) which may not be detected by the person conducting the evaluation.

It is advisable to use wave generators for the validation of the microcontroller instead of real jumpers on a contact platform, as people are incapable of making repeated jumps of equal characteristics. In addition, any variability which may be added by the contact platform would be avoided. On the other hand, the use of wave generators would require further study to ascertain whether they are the cause of the instability referred to above.

The results obtained in the validation of the microcontroller were considered to be satisfactory.

As concerns the validation of the contact platform by establishing the minimum pressure, it is necessary to know the minimum pressure needed to make a contact at different points on the platform. Table 5 shows the different sensitivities found in the platforms. Due to the difference in the materials used, the average sensitivity of the rigid platforms was approximately four times worse than the sensitivity of the flexible platform. The platform with the worst sensitivity was the A3 rigid platform, with an average of 83.776 N of force needed for activation.

Table 5: Sensitivity of the different platforms.

	Maximum (N)	Average (N)	Standard Dev.
Rigid A2	120.4	65.0	31.2
Rigid A3	133.8	83.7	37.3
Flexible	17.8	17.8	0.0

The Newton values refer to the minimum force needed for activation.

With respect to the sensitivity in each of the points of the platforms (see Figure 6), the flexible platform behaved in a very different way to the rigid platforms. Since the flexible platform was homogeneous lengthwise and widthwise, the same sensitivity was found in all of the analysed points. Furthermore, the flexible platform was more sensitive than the others. On the other hand, the rigid platforms were made up of two fiberglass plates separated by double-sided tape. This last caused the decreased sensitivity in the corners, the sides and, in the case of the rigid A2 platform, in the centre. The small differences between the rigid platforms could be explained by the location of the points being assessed since, as can be seen in Table 2, the assessment on the Din-A2 platform was carried out 1 cm. closer to the sides than on the Din-A3 platform.

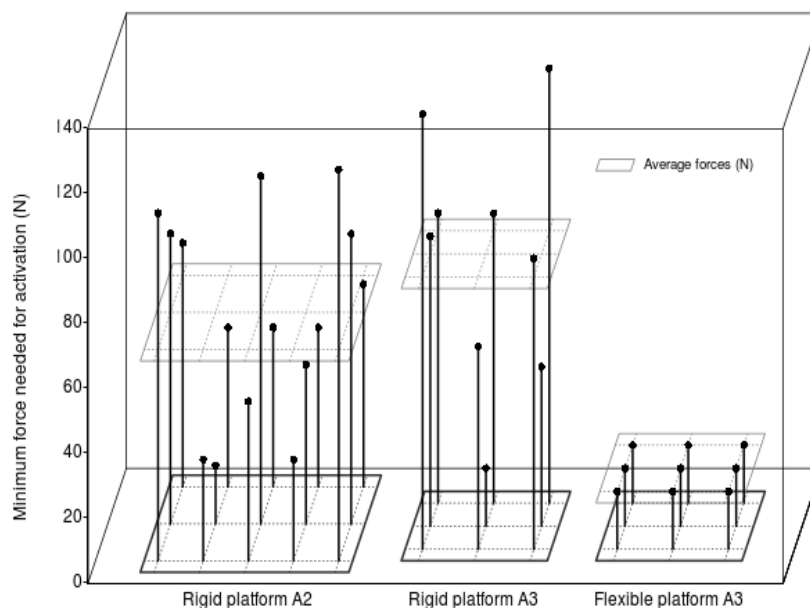

Figure 6. Sensitivity of the platforms at different points.

The highest value of force required was found in one of the corners of the A3 rigid platform (133.8 N). This value corresponds to the force exerted by a 13.6 kg. child standing on that point of the platform. Although the foot of this child is bigger than the surface of the strain gauge used, the metatarsal area is not. Therefore this child would activate the platform without even moving. It can be concluded that the sensitivity of the platforms is sufficient to

detect the take-off and landing of an individual, even more so taking into account that, upon take-off and landing, forces are exerted which are much greater than that of gravity in a standing position.

Regarding the validation by comparison of activation and deactivation times, it must be noted that the differences found between the platforms corresponded to differences in the measurements on the part of the microcontrollers and the platforms, as well as to imbalances in the jumps on the part of the jumpers. Even though the results obtained were the consequence of the three referred factors, the statistical analysis highlighted the differences between the platforms. The box chart in Figure 7 explains the reliability and the concurrent validity of the platforms. The different boxes show the percentage difference between the value of each platform in each jump. The percentage was calculated with the following formula: $\text{Relative error (\%)} = 100 * |TF_{\text{exp}} - TF_{\text{Ergo}}| / TF_{\text{Ergo}}$, where TF_{exp} is the flight time encountered in the experimental contact platform and TF_{Ergo} represented the flight time corresponding to the Ergojump-Boscosystem platform.

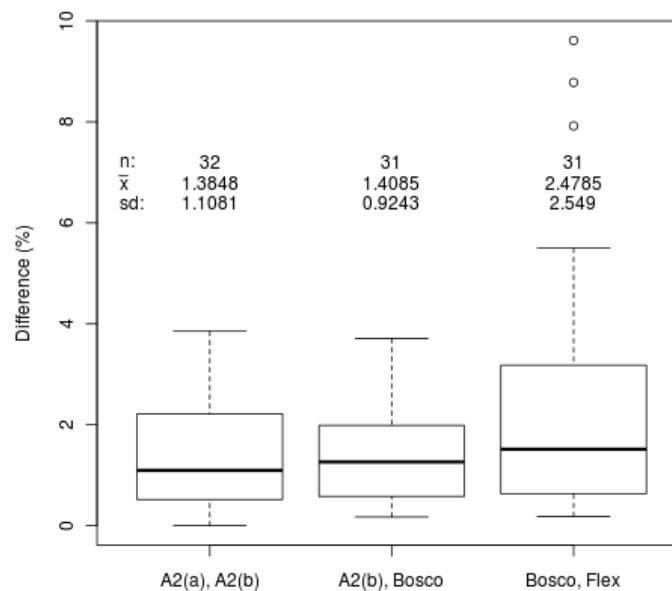

Figure 7. Validity and reliability of the proposed platforms. The subject jumped with one foot on each platform.

The first box in Figure 7 refers to the jumps made on two A2 rigid platforms, known as A2(a) and A2(b). As can be seen, the average difference was 1.38% and the deviation was 1.11. These values were considered optimum and provided a good measure of reliability. The second and third boxes correspond to the differences between the proposed platforms and the Ergojump-Boscosystem platform. This measurement represents the concurrent validity. As can be seen, the comparison between the rigid platforms and the reference measure offered optimum values, which were very similar to the comparison between rigid platforms A2(a) and A2(b). On the contrary, the flexible platform did not show such satisfactory results, and three notable errors were identified in the measurements, with percentage errors between 8% and 10%.

The absence of a standard error was then determined. Figure 8 shows that there was no tendency for a 'lateral' error, except in the three wayward values from the location in which the flexible platform was compared to the Ergojump-Boscosystem platform. In the three cases, the value of the flexible platform was greater than that of the benchmark platform. Therefore the errors were due to an early detection of the take-off, and/or to a delayed detection of the landing.

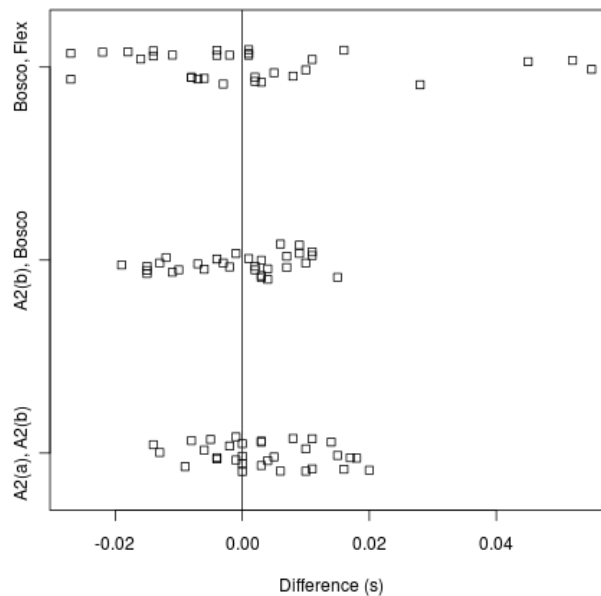

Figure 8. Standard error among the platforms. The vertical axis has been slightly altered for the sake of clarity.

Figure 9 shows the effect of the individual on the different jumps. As can be seen, the variability among subjects was even greater than the variability observed among platforms in Figure 7. It can also be appreciated that the three detection errors in the location of the flexible platform corresponded to three different subjects. Figure 10 shows that the athletes behaved in an equal manner in the different combinations of platforms.

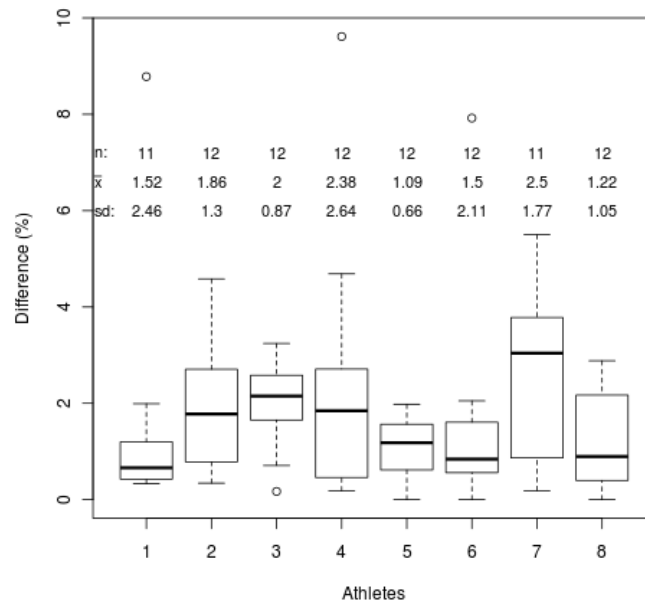

Figure 9. Difference between platforms based on each athlete's performance.

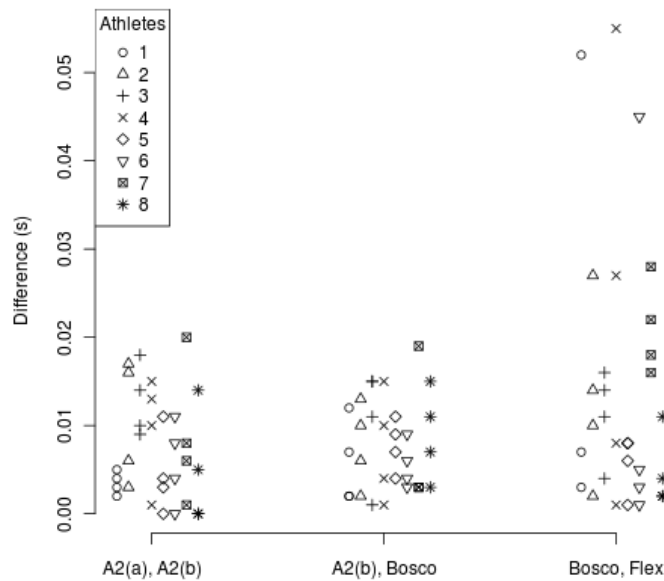
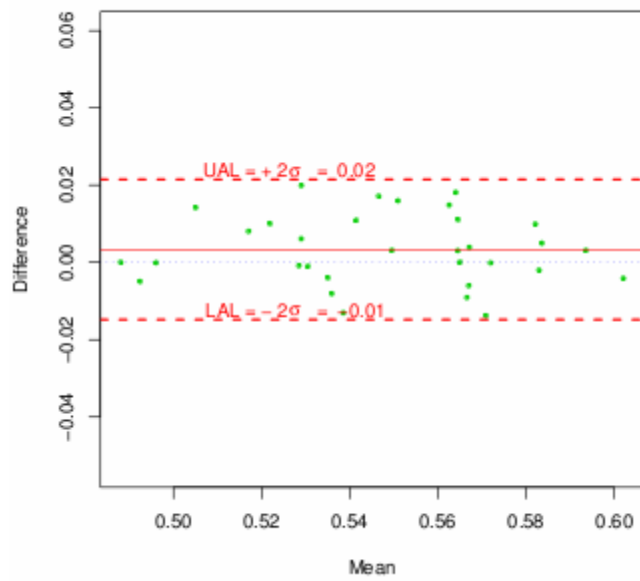
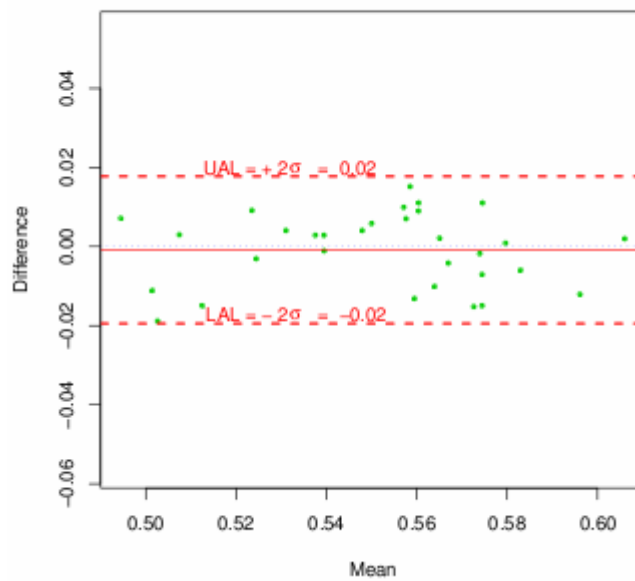

Figure 10. Difference between platforms based on location and athlete.

Continuing with the analysis of the differences among platforms, the use of Bland-Altman graphs is proposed (Figure 11). It was found again that the location being assessed on the flexible platform was the only one where values appeared outside the confidence range.



Two rigid A2 platforms.



Rigid A2 platform and the Bosco platform.

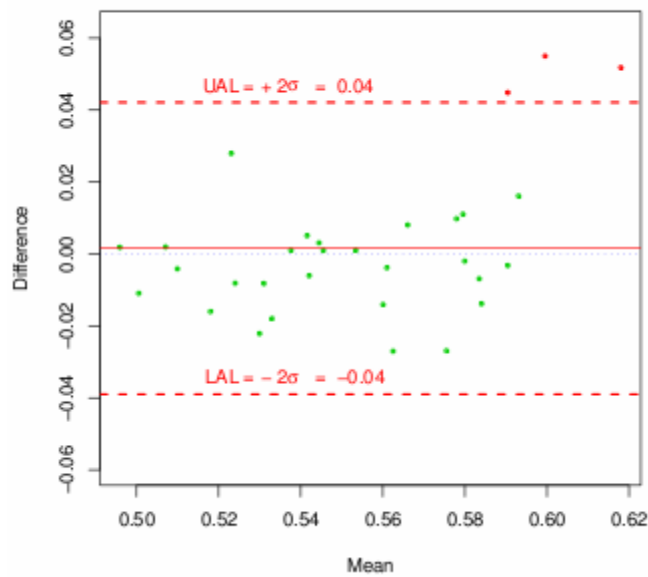

Flexible platform and the Bosco platform.

Figure 11. Bland-Altman graphs between the different platforms.

Finally, Table 6 shows the intraclass correlation coefficients (“oneway” model) in the three situations. All the results were found to be above 0.81, and thus reflected an almost perfect ‘agreement’ (Landis & Koch, 1977).

Table 6: Intraclass coefficients for the different locations.

	ICC	ICC 95% confidence
Rigid A2(a) - Rigid A2(b)	0.949	0.899 < ICC < 0.975
Rigid A2 - Bosco	0.950	0.898 < ICC < 0.975
Flexible - Bosco	0.821	0.664 < ICC < 0.909

From the results obtained, it can be concluded that the A2 rigid platform has been validated and its reliability has been established. As to the flexible platform, whilst not providing bad results, it should be perfected to ensure desirable results within the scientific field. It must be noted that the A3 rigid platform wasn't validated with this method because we understand that his behaviour will be very similar to the A2 rigid platform as the sensitivity validation has shown.

Current study is an opposite approach from the work of García-López et al. (2005). That research connected a new contact platform both to new SportJump system and the computer of Ergojump-Boscosystem (Psion Organiser II). On the other hand, our study validated first the Chronopic 3 microcontroller and then used it to compare the contact platforms described and Ergojump-Boscosystem platform folded. The aforementioned research found that Psion

Organiser II seems to underestimate flight time by 14 ms (2.9 %), attaching it to a data filtering program on that computer in order to avoid double contacts, but they did not described how they managed to ensure that both systems do not interfere in the measurement of electrical signal. Regarding the measurement error using contact platforms, García-López et al. (2008) commented that jump height in a contact platform has a small overestimation error in comparison with a force platform, and this error seem to be related to the pressure that needs to be done on the contact platform.

Measurement systems based on laser beams underestimate flight time and this error increases in the instruments with higher position of the laser beams (Viitasalo et al., 1992). For this reason, García-López et al. (2008) proposed to correct measured data in the different systems, subtracting 9.2 ms in a mechanical contact platform like SportJump 1.0 and adding flight time in laser devices: 10.6 ms for SportJump System Pro and 50.8 for ErgoJump Plus. Borges Junior et al. (2011) found a understimation of jump height of 0.30% in SaltoBras compared to a force platform, they also added a formula in the software in order to correct flight time.

Other studies used a camera motion analysis system as reference. Eg. Leard (2007) found a Pearson r between a 3-camera motion analysis system and the contact platform JustJump of 0.967, and a Pearson r between the same camera system and the Vertec of 0,906.

As the suggestion of Gold Standard for measure jump height differs between authors like Aragon-Vargas (2000) who prefers the video camera, versus Hatze (1998) and García López et al. (2005) opting for the use of force platform, we suggest to perform a new study that compares the Chronojump-Boscosystem with a force platform and a high speed video camera system in order to know the difference between them and decide if there's a need to adjust the calculation of flight time.

Conclusion

A microcontroller, fiberglass contact platforms, and computer software have been created to be used in the measurement of vertical jump times. All three products have been designed using free software and the final product is also free/open. The tools have been validated with satisfactory results. The software allows users to define their tests, as well as use predefined tests, including the protocol for the Bosco Test, other types of jumps and other time-related sports tests, whether they are races, rhythms or reaction times. Besides showing the results of a test, the software provides configurable feedback, which makes it possible to change the duration of a repetitive test. The programme is available in 7 languages and can be run on two operating systems. The information about the construction of all the tools is in the public domain and as a result, they can be produced by anyone.

The free/open licenses granted allow any interested party to review the designed tools in depth, and to purchase and/or build them at low-cost without violating any ethical or legal standards.

References

- Aragon-Vargas, L.F. (2000). Evaluation of four vertical jump tests: Methodology, reliability, validity and accuracy. At: *Measurement in Physical Education and Exercise Science* 4, p. 215-228.
- Black Duck Software, Inc. (2012). *Ohloh: Chronojump estimated cost*. Recuperated from http://www.ohloh.net/p/10015/estimated_cost.
- Bobbert, M.F. (1990). Drop jumping as a training method for jumping ability. At: *Sports Med* 9.1, p. 7-22. doi: 10.2165/00007256-199009010-00002.
- Boehm, B.W. (1984). Software engineering economics. At: *Software Engineering, IEEE Transactions* 1, p. 4-21. doi: 10.1109/TSE.1984.5010193.
- Borges Junior, N.G.; Borges, L.; Dias, J.A.; Wentz, M.D.; Mattos, D.J.S.; Petry, R., & Domenech, S.C. (2011). Validity of a new contact mat system for evaluating vertical jump. At: *Revista de Educação Física (online)*. 17.1, p. 26-32.
- Bosco, C. (1986). The effect of extra-load conditioning on muscle performance in athletes. At: *Med Sci Sports Exerc* 18.8, p. 415-419. doi: 10.1249/00005768-198608000-00009.
- Bosco, C. (1987). Valoraciones funcionales de la fuerza dinámica explosiva y de la potencia anaeróbica aláctica con el test de Bosco. At: *Apuntes de medicina del deporte* 24, p. 151-158. Recuperated from http://www.apuntes.org/apuntes/ctl_servlet?_f=60&ident=13104976.
- Bosco, C.; Luhtanen, P., & Komi, P.V. (1983). A simple method for measurement of mechanical power in jumping. At: *European Journal Applied Physiology Occupational Physiology* 51.3, p. 357-364. doi: 10.1007/BF00422166.
- Buscà, B.; De Blas, X., & Daza, E. (2004). *Instruction on how to build a contact platform in order to measure the jump capacity*. Recuperated from http://chronojump.org/construction_contact_platform.html.
- Casartelli, N.; Müller, R., & Maffiuletti, N.A. (2010). Validity and reliability of the myotest accelerometric system for the assessment of vertical jump height. At: *Journal of Strength and Conditioning Research* 24.11, p. 3186-3193. doi: 10.1519/JSC.0b013e3181d8595c.
- Chronojump (n.d.). *Chronojump's GIT*. Recuperated from <http://git.gnome.org/browse/chronojump/tree>.
- De Blas, X., y González-Gómez, J. (2005). Proyecto Chronojump: Sistema de Medida de la Capacidad de Salto usando Software y Hardware Libres. At: *Actas I Congreso de Tecnologías del Software Libre*.
- Departamento de Defensa de los Estados Unidos (2009). *Clarifying Guidance Regarding Open Source Software (OSS)*. Recuperated from <http://cio-nii.defense.gov/sites/oss/2009OSS.pdf>.
- DiBona, C. (2011). *Google, NASA and Open Source*. Recuperated from <http://www.slideshare.net/ckleclerc/2011-nasa-open-source-summit-chris-dibona>.
- Fowler, M., & Highsmith, J. (2001). The agile manifesto. At: *Software Development* 9.8, p. 28-35.
- Galli, R. (2004). *¿De qué viviremos los informáticos?, y tú ¿por qué no enseñas gratis?* Recuperated from <http://bulma.net/body.phtml?nIdNoticia=1961>.

- García-López, J.; Peleteiro, J.; Rodríguez-Marroyo, J.A.; Morante, J.C.; Herrero, J.A., & Villa, J.G. (2005). The Validation of a New Method that Measures Contact and Flight Times During Vertical Jump. At: *International Journal of Sports Medicine* 26, p. 294-302.
- García-López, J.; Rodríguez-Marroyo, J. A.; Pernía, R.; Ávila, M. C., & Villa, J. G. (2008). El tipo de plataforma de contacto influye en el registro de la altura de salto vertical estimada a partir del tiempo de vuelo. At: *Motricidad: revista de ciencias de la actividad física y del deporte* 21, p.1-15.
- Gbdirect (n.d.). *Benefits of Using Open Source Software*. Recuperated from <http://open-source.gbdirect.co.uk/migration/benefit.html>.
- Gómez, R., y González, J. (2008). *Página técnica de Chronopic 3*. Recuperated from http://www.iearobotics.com/wiki/index.php?title=Chronopic_3.0.
- González-Barahona, J.M. (2003). *El software como servicio. O de cómo producir programas libres y no morir en el intento*. Recuperated from <http://sinetgy.org/~jgb/articulos/software-servicio/>.
- González, I.; González, J., y Gómez-Arribas, F. (Sept. 2003). *Hardware libre: clasificación y desarrollo de hardware reconfigurable en entornos GNU/Linux*. Escuela Politécnica Superior, Universidad Autónoma de Madrid. Recovered from <http://www.iearobotics.com/personal/juan/publicaciones/art4/index.html>.
- González-Gómez, J., y Prieto-Moreno, A. (2005). *Hardware Libre: la Tarjeta Skypic, una Entrenadora para Microcontroladores PIC*. I Congreso de Tecnologías de Software Libre. Facultad de Informática, A Coruña. Recuperated from <http://www.iearobotics.com/personal/juan/publicaciones/art9/index.html>.
- Hatze H. (1998). Validity and reliability of methods for testing vertical jumping performance. At: *Journal of Applied Biomechanics* 14, p. 127-140
- Kibele, A. (1998). Possibilities and limitations in the biomechanical analysis of countermovement jumps: a methodological study. At: *Journal of Applied Biomechanics* 14, p. 105-117.
- Landis, J.R., & Koch, G.G. (1977). The measurement of observer agreement for categorical data. At: *Biometrics*, p. 159-174. doi: 10.2307/2529310.
- Lara, A. J. (2007). «Biomecánica de la arquitectura muscular y potencia mecánica de salto en jóvenes». PhD Thesis Toledo: Universidad de Castilla-La Mancha.
- Leard, J.S.; Cirillo, M.A.; Katsnelson, E.; Kimiatek, D.A.; Miller, T.W.; Trebincevic, K., & Garbalosa, J.C. (2007). Validity of two alternative systems for measuring vertical jump height. At: *Journal of strength and conditioning research* 21.4, p. 1296-1299.
- Linthorne, N.P. (2001). Analysis of standing vertical jumps using a force platform. At: *American Journal of Physics* 69, p. 1198-1204. doi: 10.1119/1.1397460. Recuperated from <http://dspace.brunel.ac.uk/bitstream/2438/1392/3/Standing+Vertical+Jump+%28Linthorne%29.pdf>
- López, J.L.; Padullés, J.M., y Tous, J. (1999). «Nuevas tendencias en fuerza y musculación». At: *ERGO*. Cap. Valoración del entrenamiento de la fuerza, p. 182-204.
- Padullés, J.M. (2011). «Valoración de los parámetros mecánicos de la carrera. Desarrollo de un nuevo instrumento de medición». PhD Thesis Barcelona: INEFC, Universitat de Barcelona.

- Padullés, J.M., & De Blas, X. (n.d.) *Construction of a modular contact platform using printed circuits*. Recuperated from http://chronojump.org/construction_modular_circuit_platform.html
- Parker, K.A. (2000). *Open Sources And The Open Society*. Recuperated from <http://agora.ph.i.gvsu.edu/kap/OSFS/OSFSEssay.pdf>.
- Picerno, P.; Camomilla, V., & Capranica, L. (2011). Countermovement jump performance assessment using a wearable 3D inertial measurement unit. At: *Journal of Sports Sciences* 29.2, p. 139-146. doi: 10.1080/02640414.2010.523089.
- Portolés, J. (1994). Entrenamiento de la fuerza en el fútbol. At: *Actualizaciones en Fisiología del Ejercicio* 2.1, p. 24-38.
- R Development Core Team (2008). *R: A Language and Environment for Statistical Computing*. R Foundation for Statistical Computing. Vienna, Austria. Recuperated from <http://www.R-project.org>.
- Sargent, D.A. (1921). The physical test of a man. At: *Am Phys Educ Rev* 26, p. 188-194.
- Stallman, R. (2002). The free software definition. At: *Free Software Free Society: Selected Essays of Richard M. Stallman*, p. 41-44.
- Thompson, C.J. & Bembien, M.G. (1999). Reliability and comparability of the accelerometer as a measure of muscular power. At: *Medicine & Science in Sports & Exercise* 31.6, p. 897. doi: 10.1097/00005768-199906000-00020.
- Viitasalo, J.T.; Luhtanen, P.; Monone, H.V.; Norvapalo, K.; Paavolainen, L., & Salonen, M. (1997). Photocell contact mat: a new instrument to measure contact and flight times in running. At: *Journal of Applied Biomechanics* 13.2, p. 254-266.
- Wheeler, D.A. (2007). *Why open source software/free software (OSS/FS, FLOSS, or FOSS)? Look at the numbers*. Recuperated from http://www.dwheeler.com/oss_fs_why.html.
- Wheeler, D.A. (2011). *Open Source Software (OSS or FLOSS), the U.S. Department of Defense (DoD), and NASA*. Recovered from <http://www.slideshare.net/ckleclerc/2011-nasa-open-source-summit-david-wheeler>.