

# SCF

## PROPELLER CONTROLS

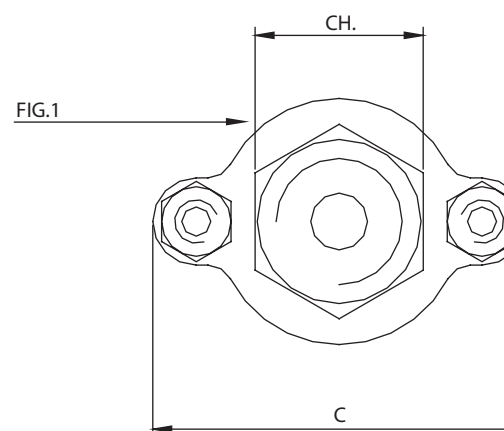
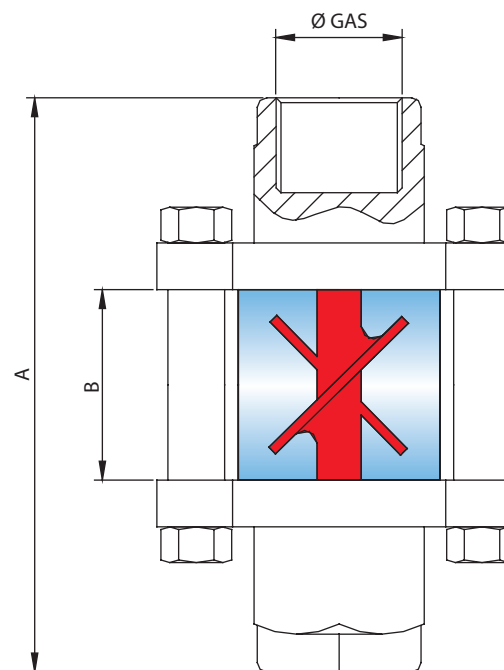

# SCF

## PROPELLER CONTROLS

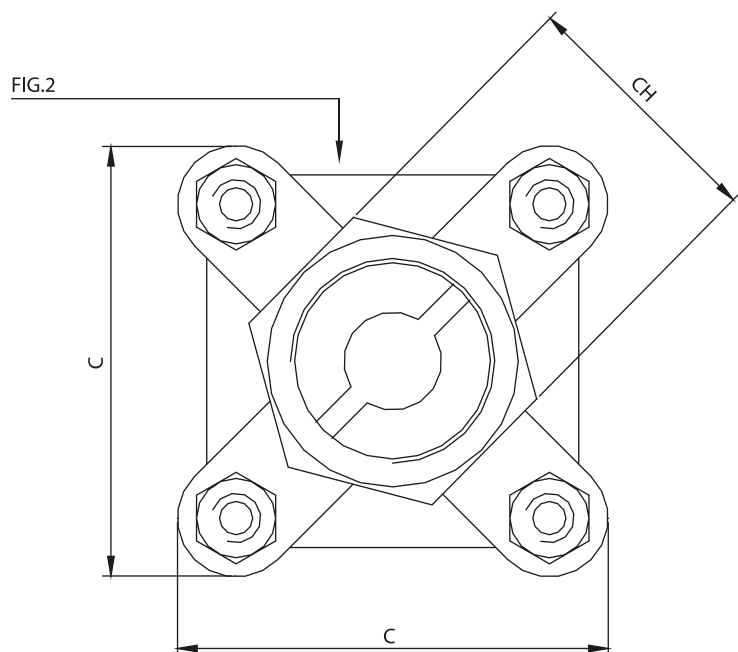

Designed to control the circulation of liquids, they are suitable for the flow of water, oils, petrol, gas oil and all other liquids except corrosive liquids.

- Body in chromed zinc brass alloy with hexagonal boss and internal thread for the connection.
- Reversible propeller in nylon-glass.
- Tube in Pyrex glass.
- Max. operating temperature 90°C with nitrile seal and 130°C with Viton seal.
- Possibility OR FKM and aluminum propeller.

TYPE	CONNECTION	A	B	C	CH.	FIG.	MIN. FLOWRATE (Lit/Min)*	MAX. FLOWRATE (Lit/Min)*	MAX. PRESSURE (Bar)	MAX. TEMPERATURE (°C)
SCF 13	1/4 " GAS	66	22	37	17	1	0,6	3	30	90
SCF 16	3/8 " GAS	94	31	58	27		1,1	5,5		
SCF 20	1/2 " GAS						1,3	6,3		
SCF 26	3/4 " GAS	128	47	67	42	2	1,6	17	15	
SCF 33	1 " GAS						2,2	27		
SCF 42	1"1/4 GAS	156	66	80	60		9	55		
SCF 48	1"1/2 GAS					11	60			

\* The values indicated, are referred to the passage of water