

Sekvensstyrning

Enkel sekvens

Exempel

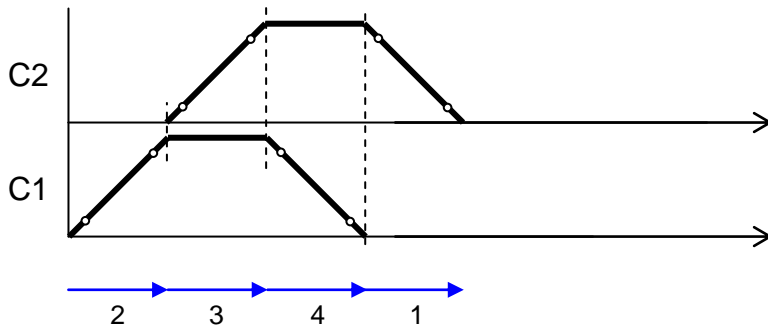

Lösning

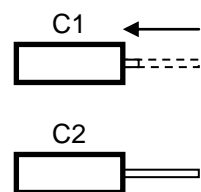
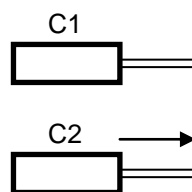
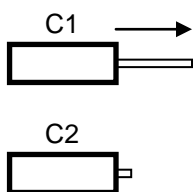
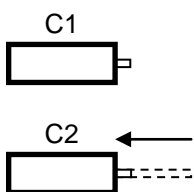
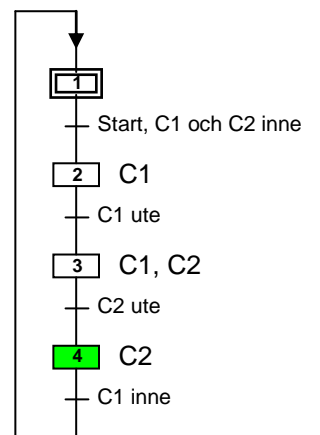
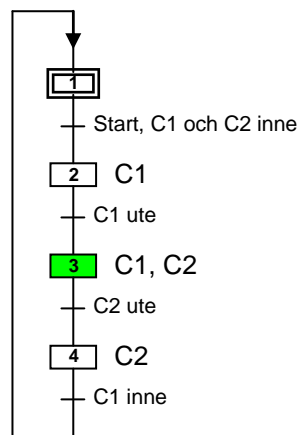
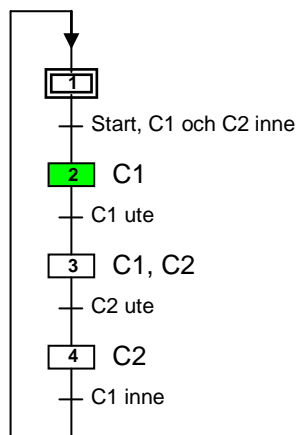
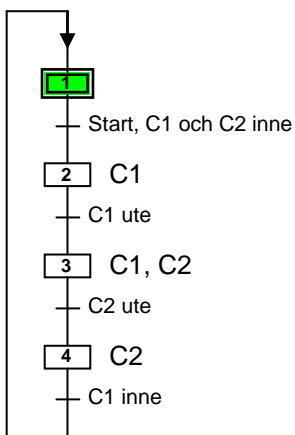
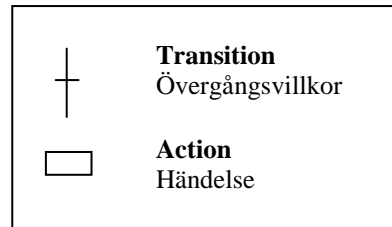
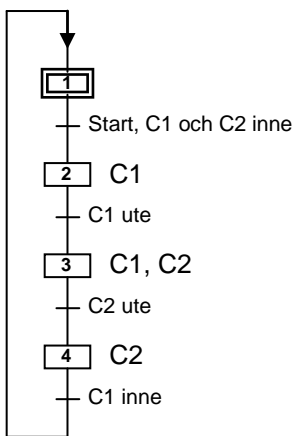

Lösningen förutsätter monostabila ventiler för C1 och C2.